

# CHAMBORD 41

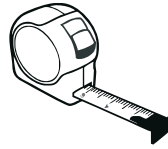

OPTION L

OPTION R

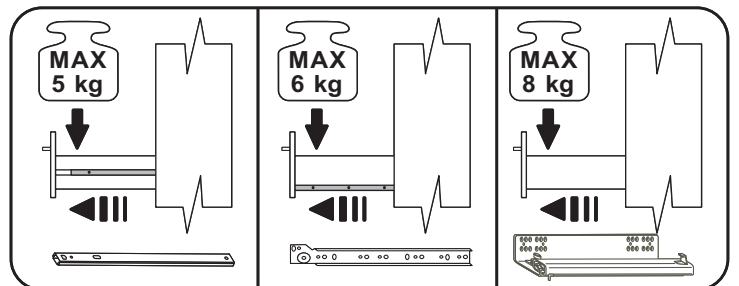
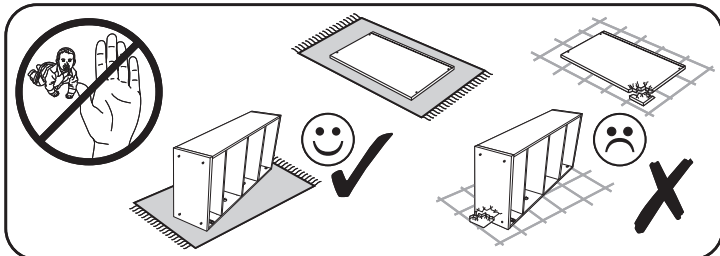
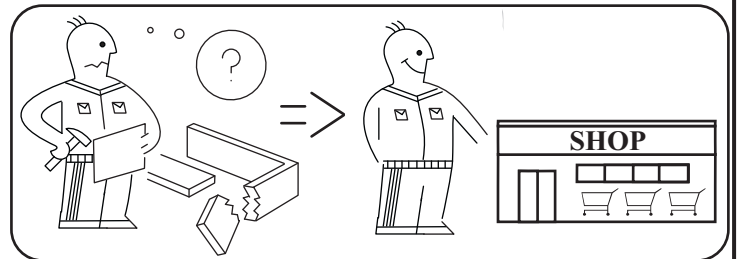
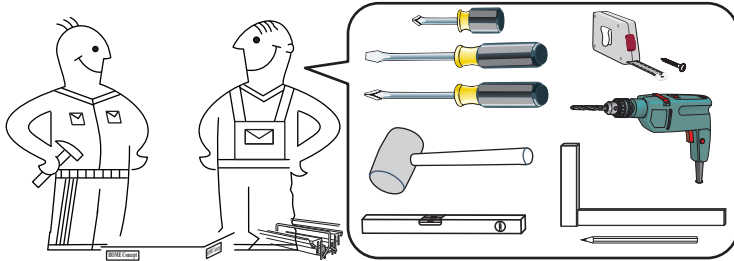
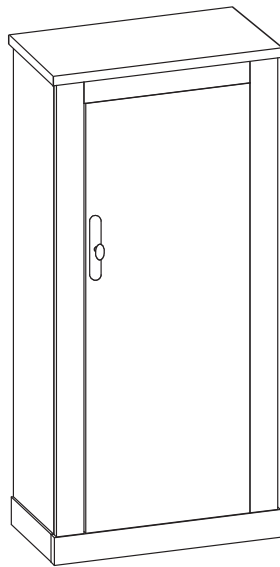
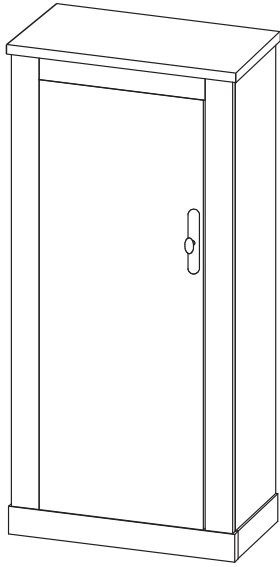

# CHAMBORD 41

max.



7KG

HC3

HC5

HC12

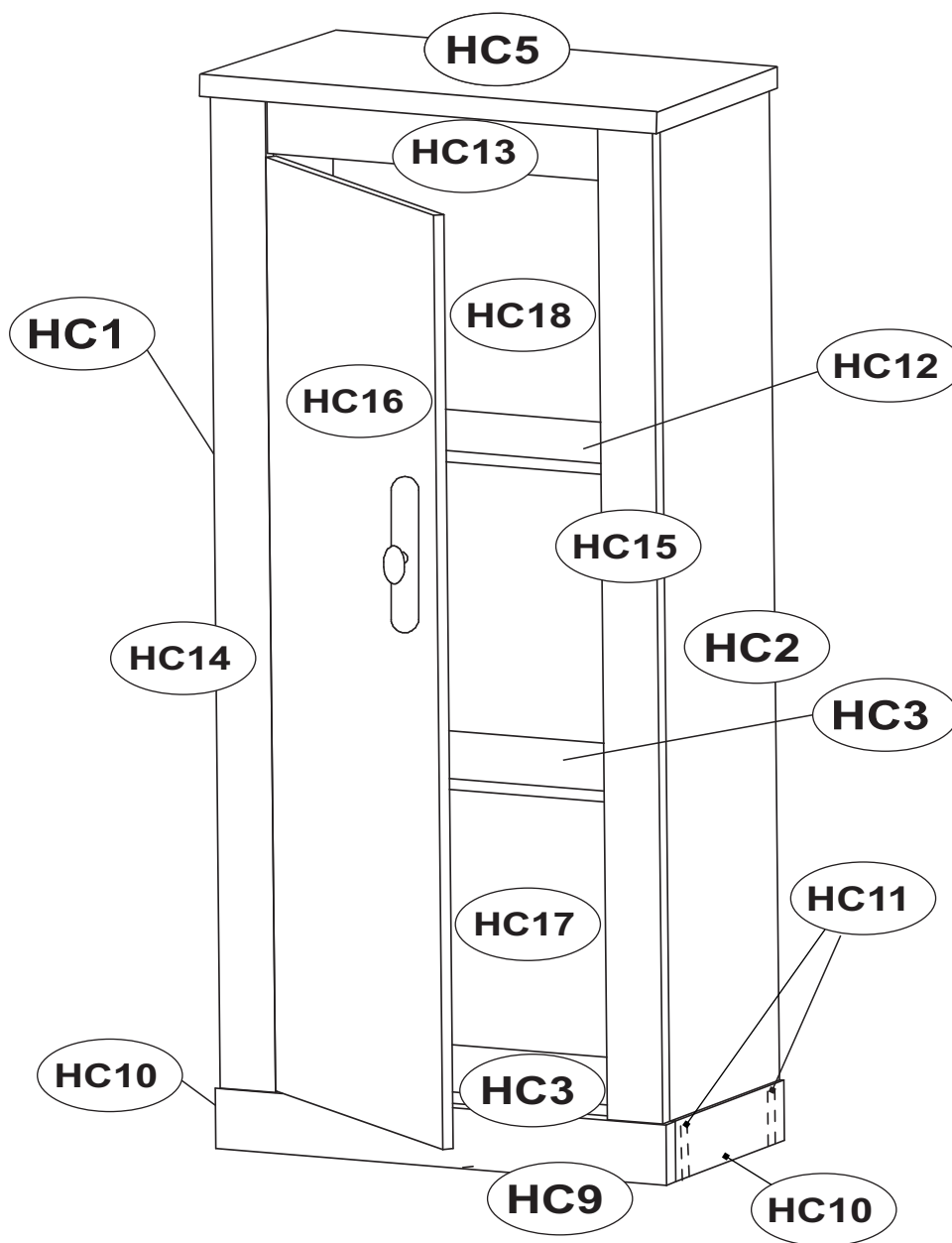



HC 1	1311	320	15	1/1
HC 2	1311	320	15	1/1
HC 3	611	299	15	1/1
HC 5	681	362	28	1/1
HC 9	656	80	28	1/1
HC 10	317	80	28	1/1
HC 11	598	80	15	1/1

HC 12	610	267	15	1/1
HC 13	483	70	18	1/1
HC 14	1311	80	22	1/1
HC 15	1311	80	22	1/1
HC 16	1235	477	15	1/1
HC 17	421	623	2,5	1/1
HC 18	895	623	2,5	1/1

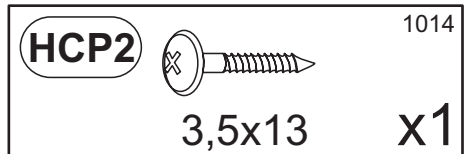
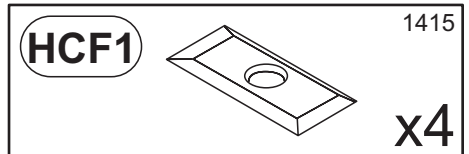
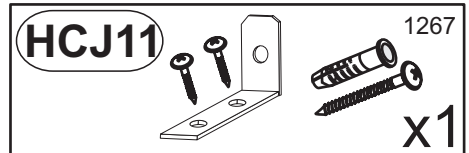
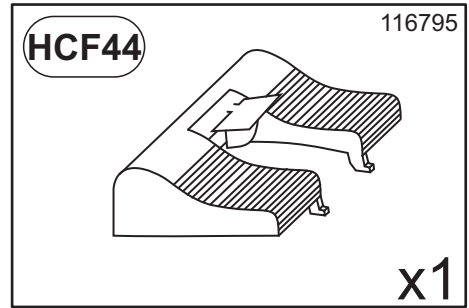
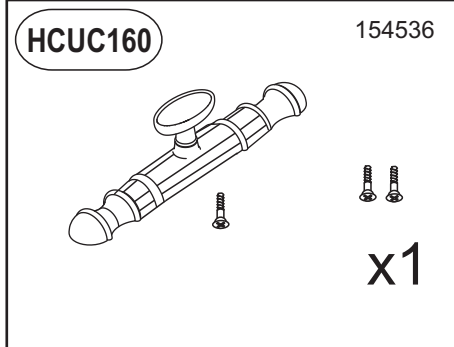
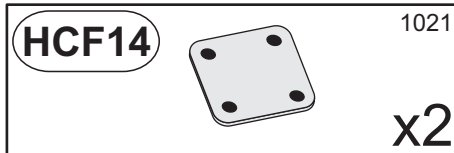
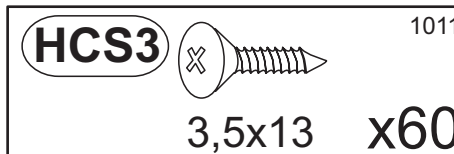
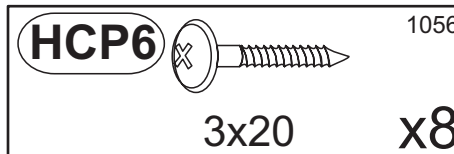
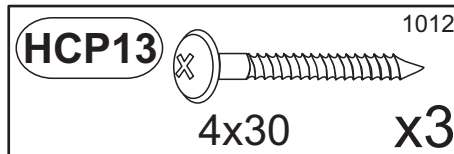
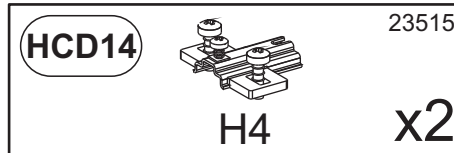
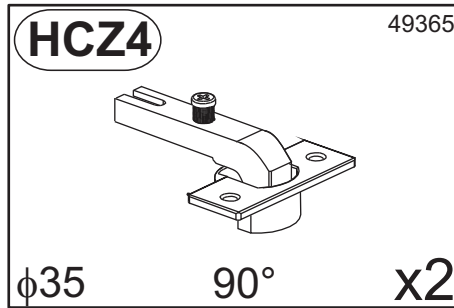
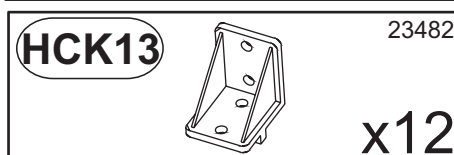
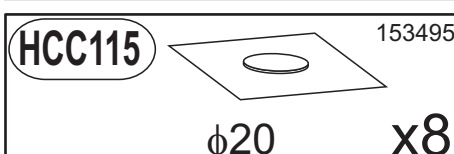
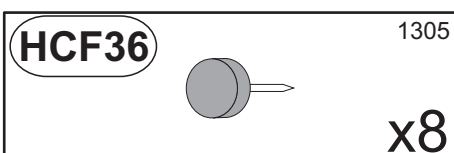
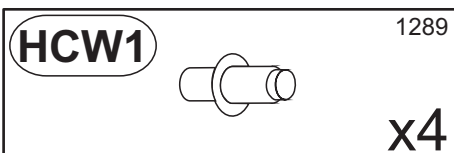
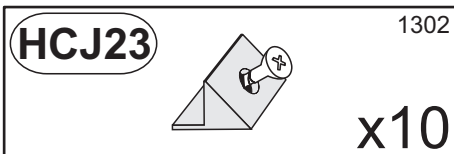
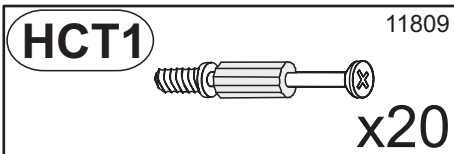
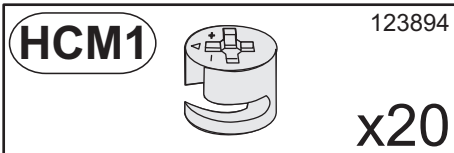
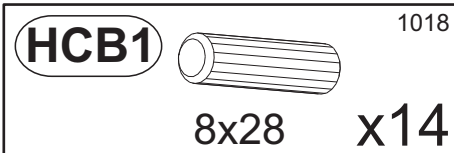
# CHAMBORD 41

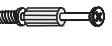

1

HCB1		1018
	8x28	x4
HCM1		123894
		x4
HCT1		11809
		x8

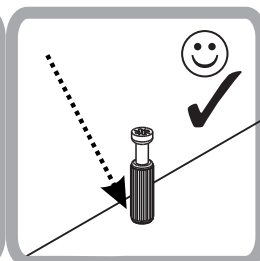
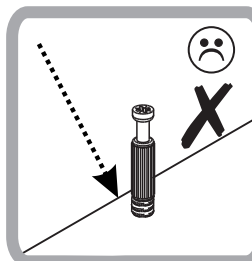
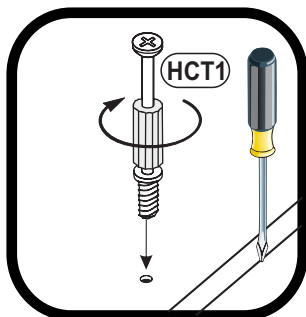
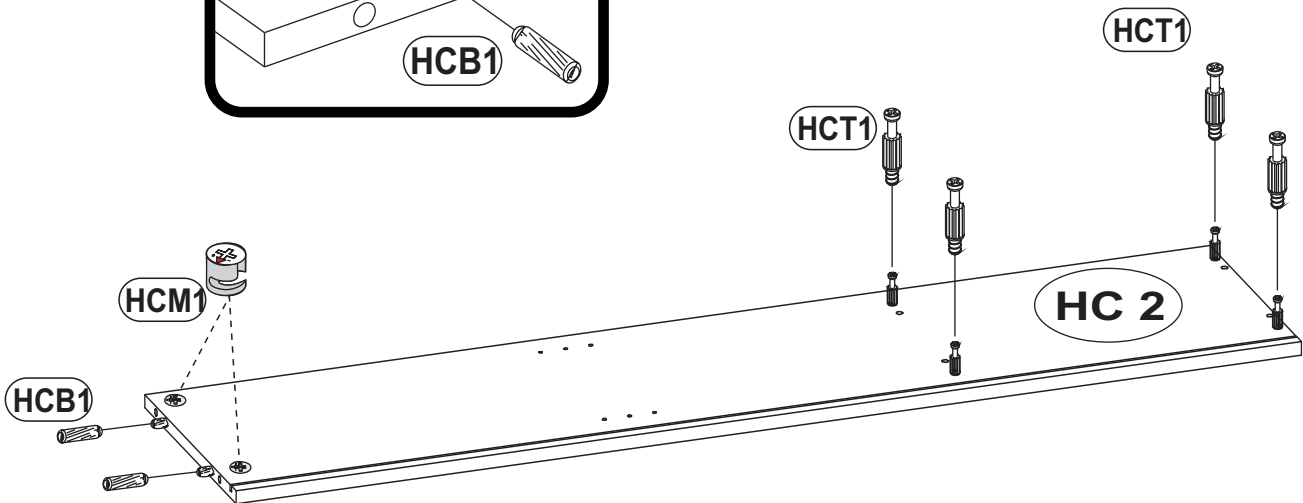
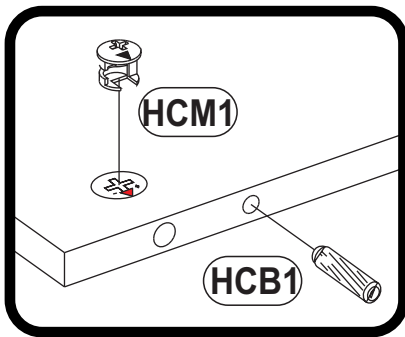
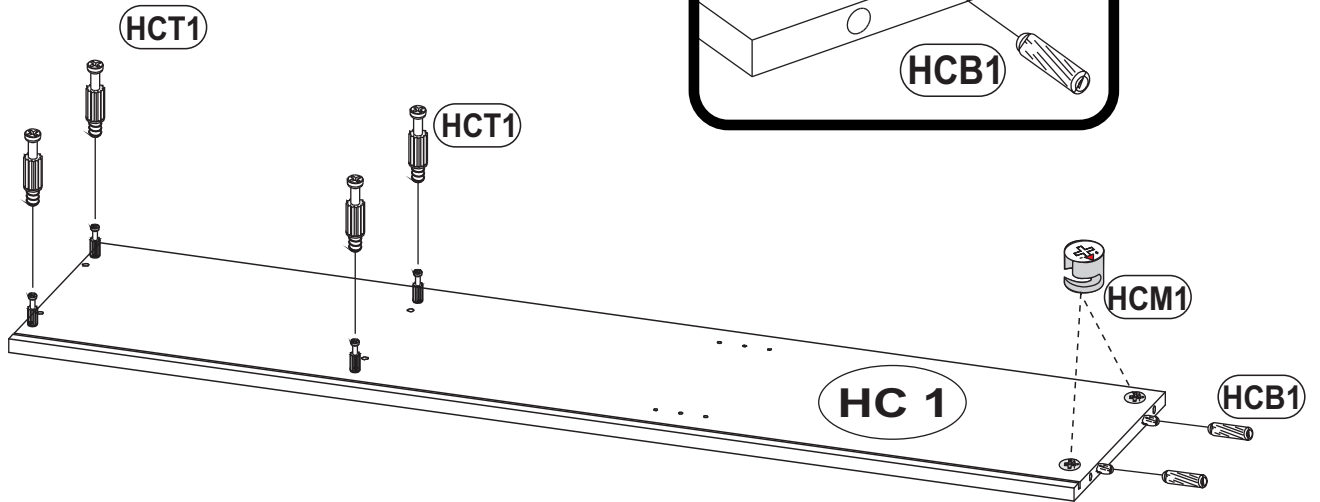
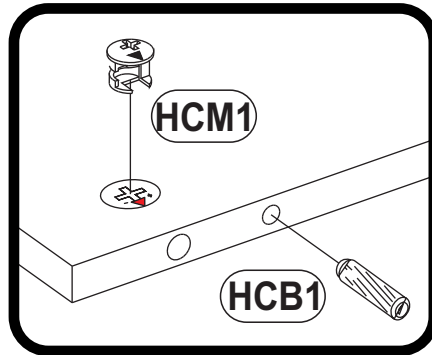
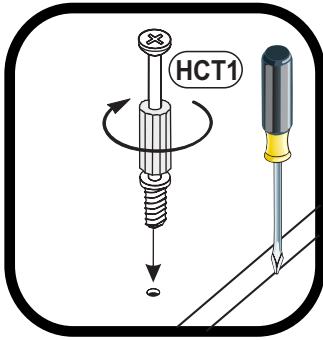

2

OPTION L

<b>HCS3</b>		1011
3,5x13		x16

<b>HCD14</b>		23515
H4		x2

<b>HCK13</b>		49716
		x8

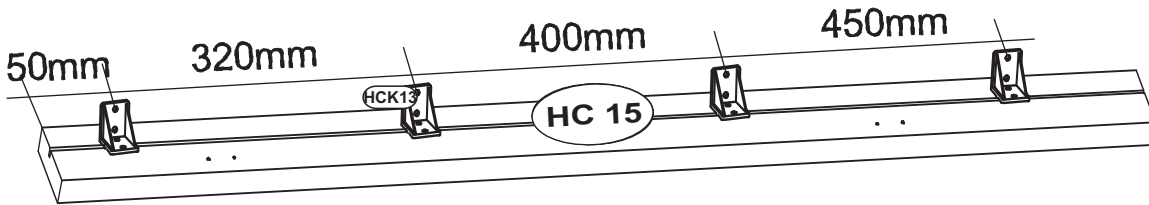
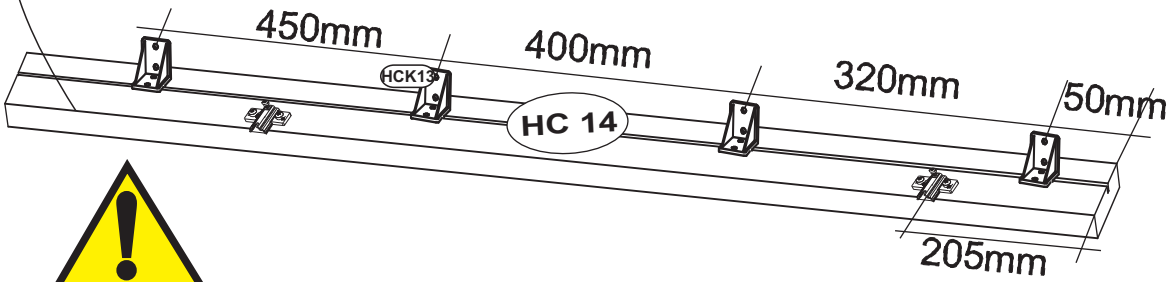
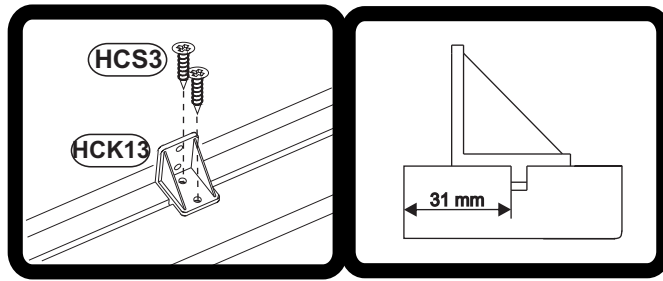
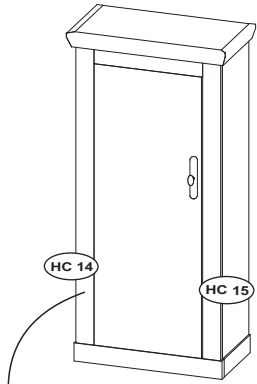
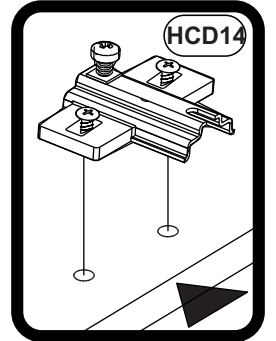

OPTION R



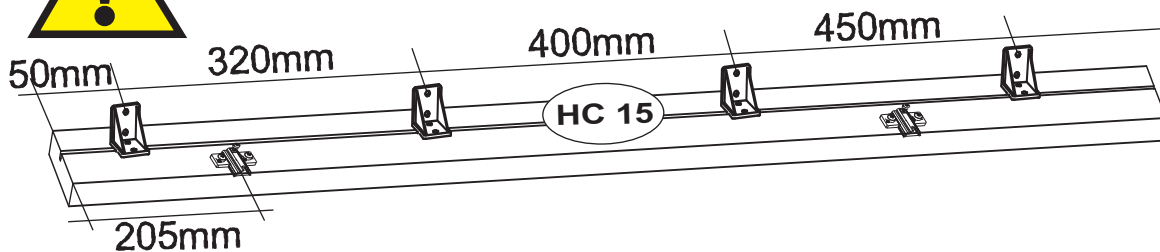
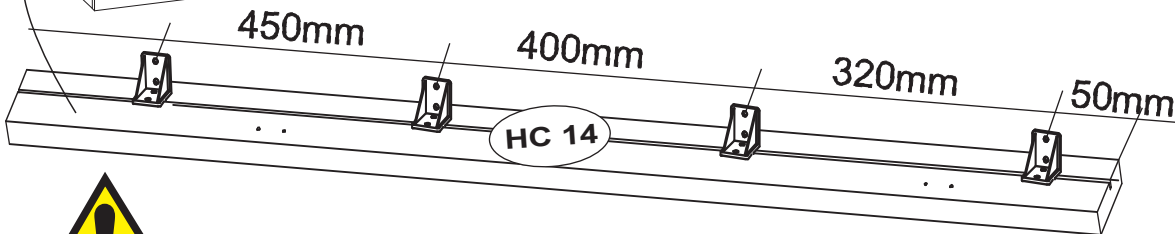
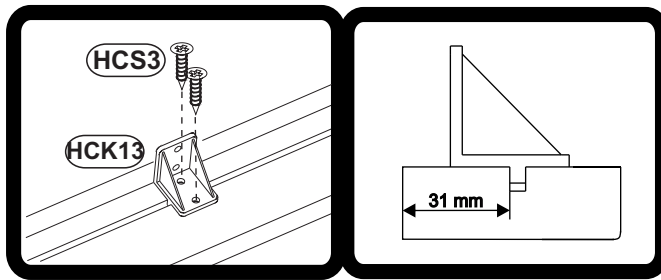
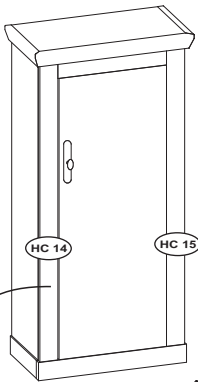
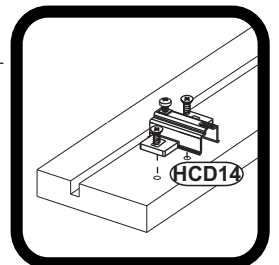

<b>HCS3</b>		1011
3,5x13		x16

<b>HCD14</b>		23515
H4		x2

<b>HCK13</b>		49716
		x8



3

<b>HCF14</b>  1021 x2	<b>HCB1</b>  8x28 1018 x8
<b>HCS3</b>  3,5x13 1011 x4	<b>HCM1</b>  123894 x8

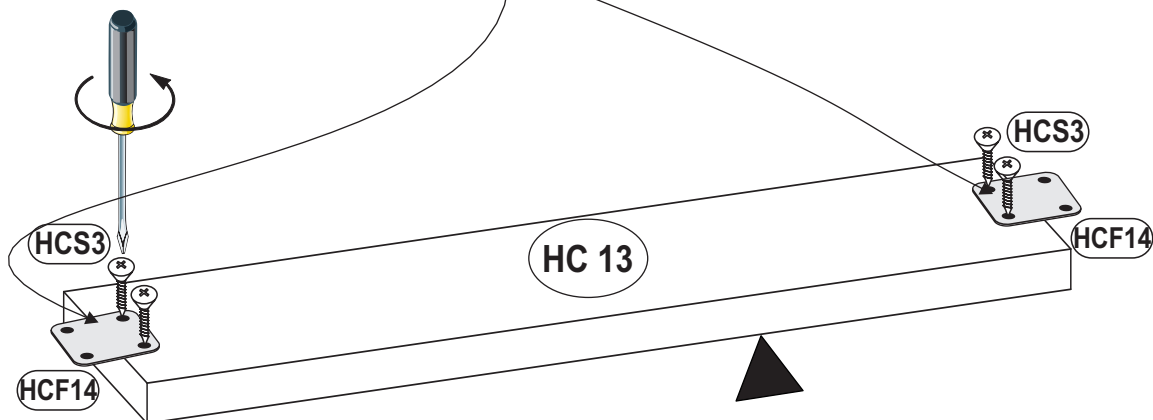
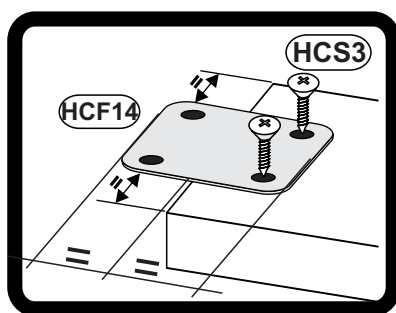
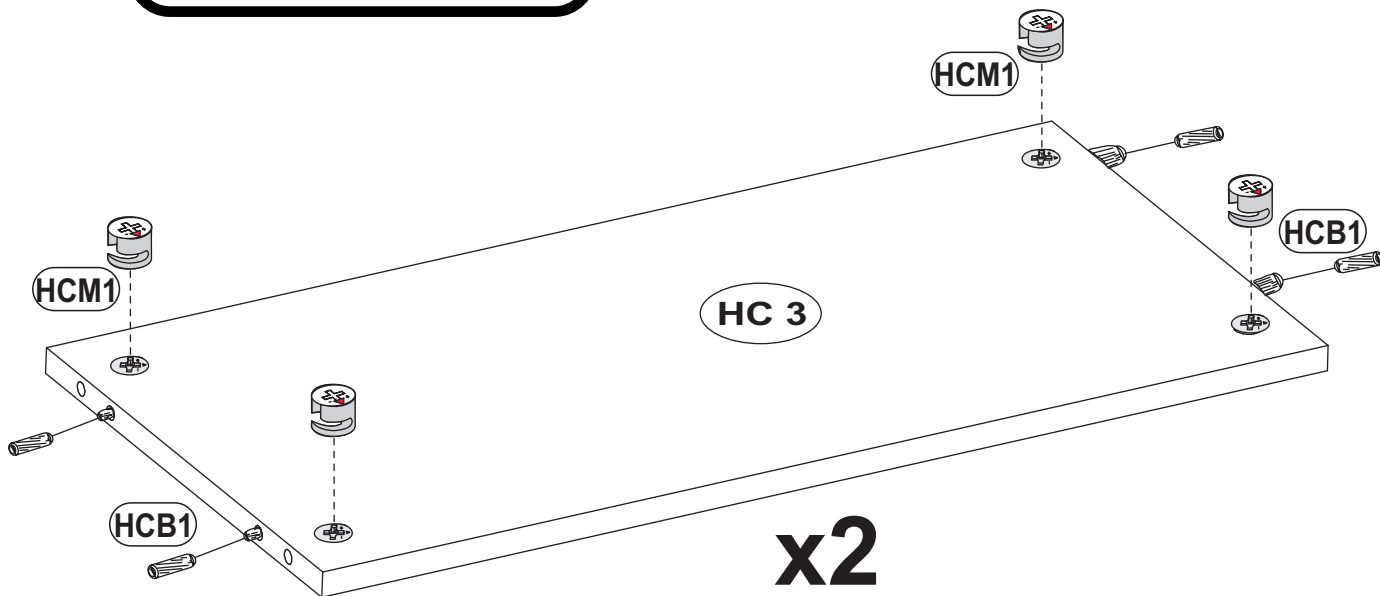
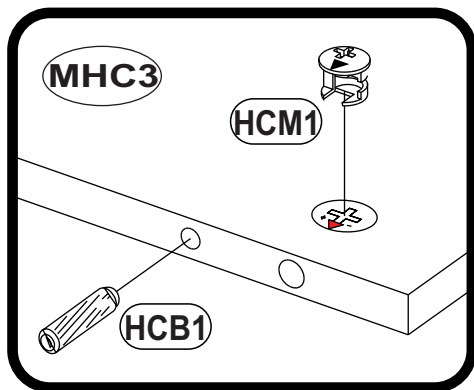

4

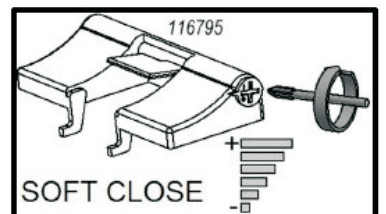
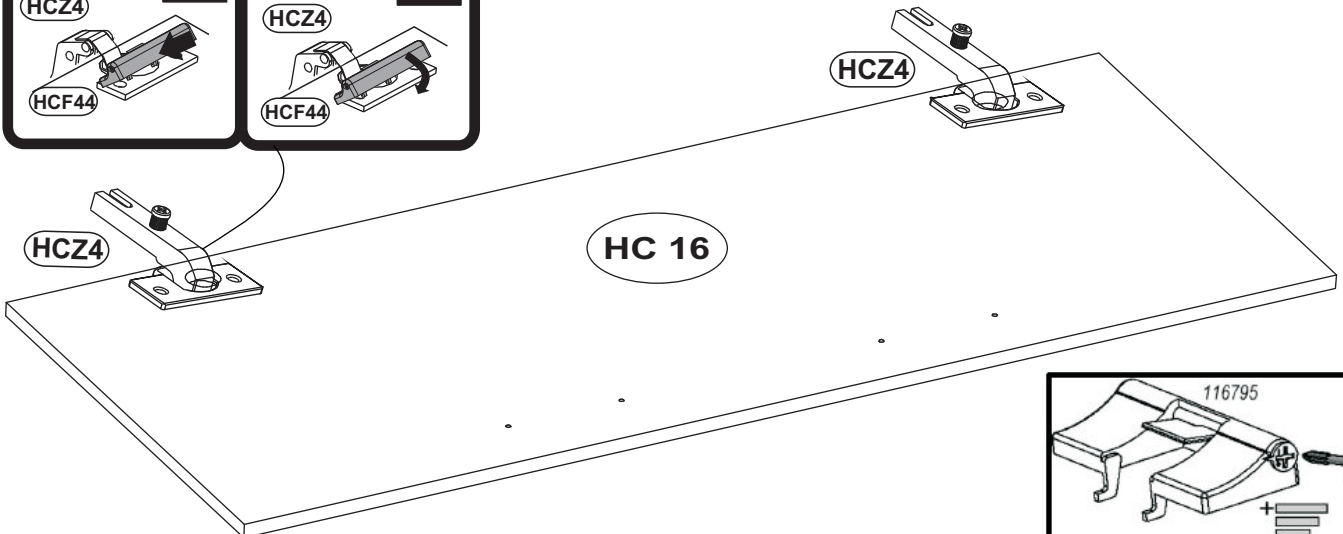
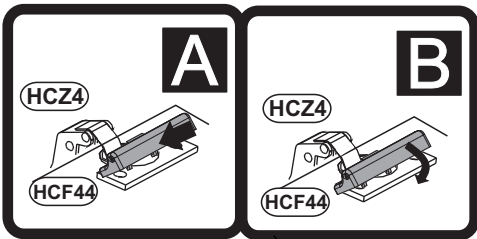
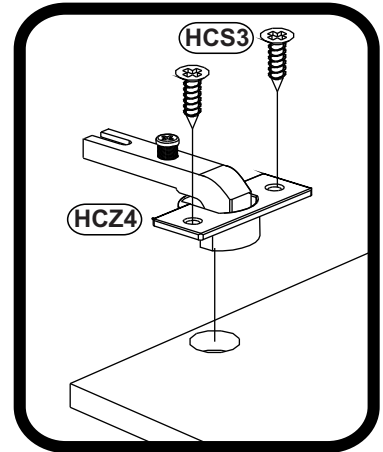
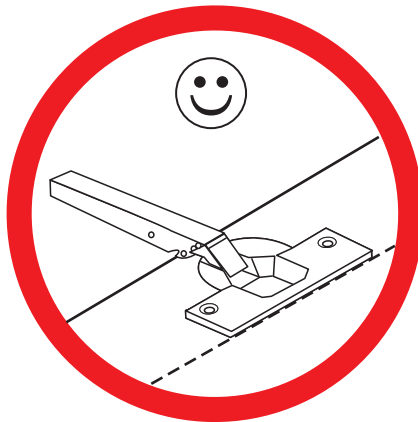
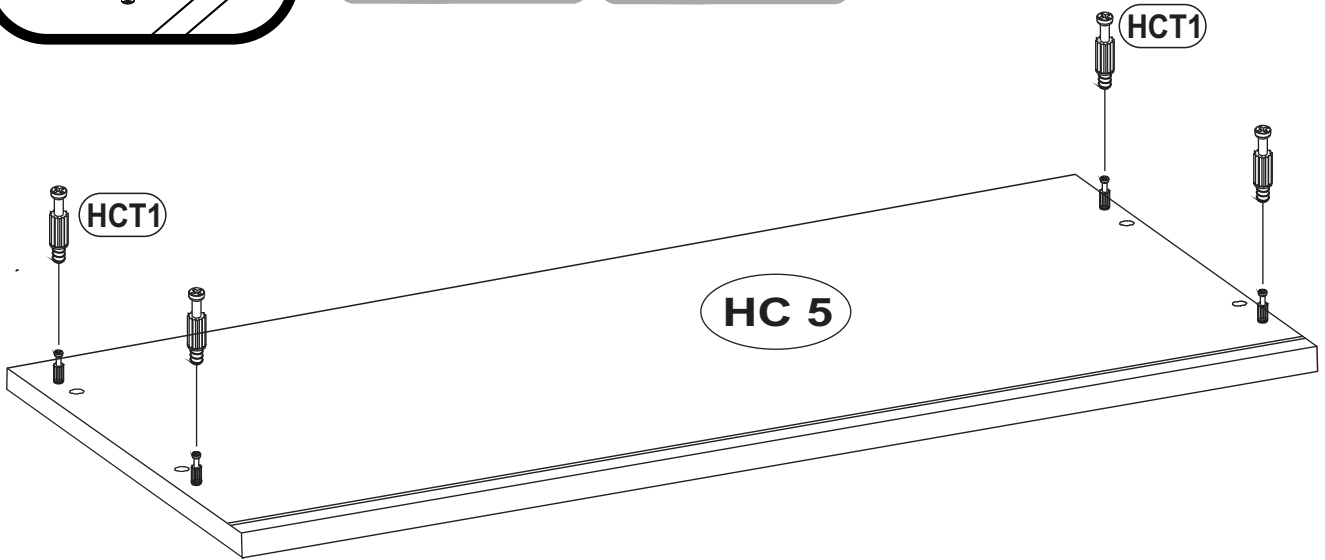
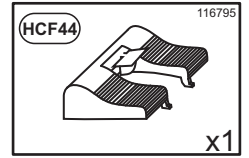
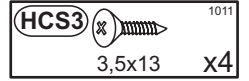
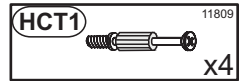
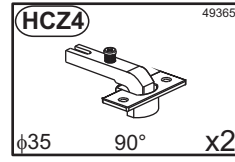
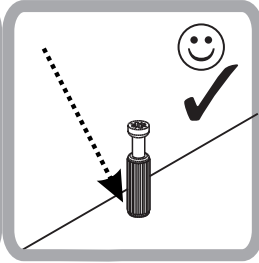
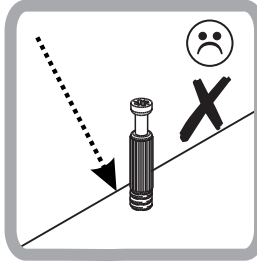
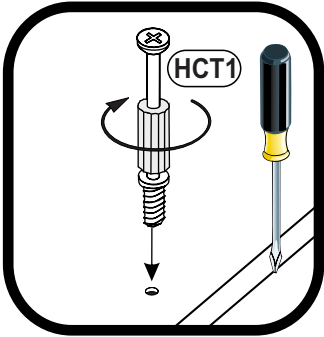

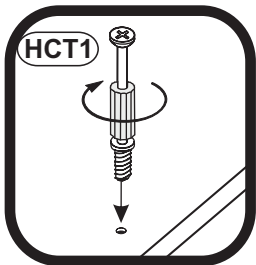
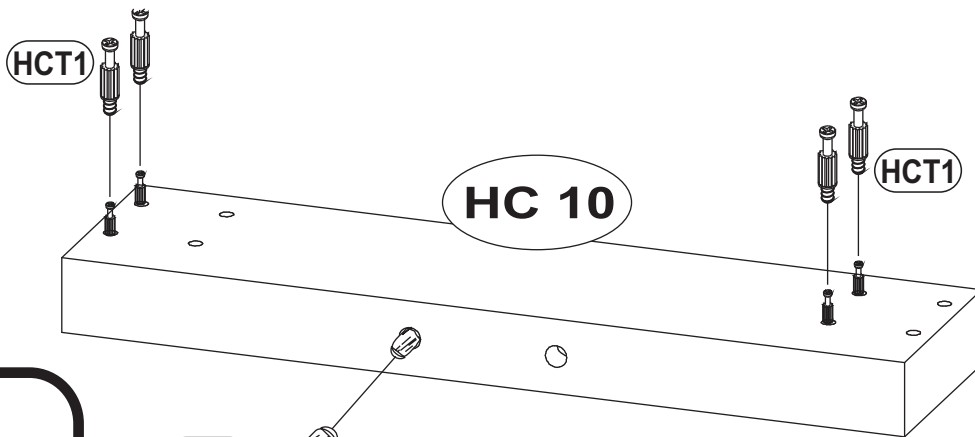
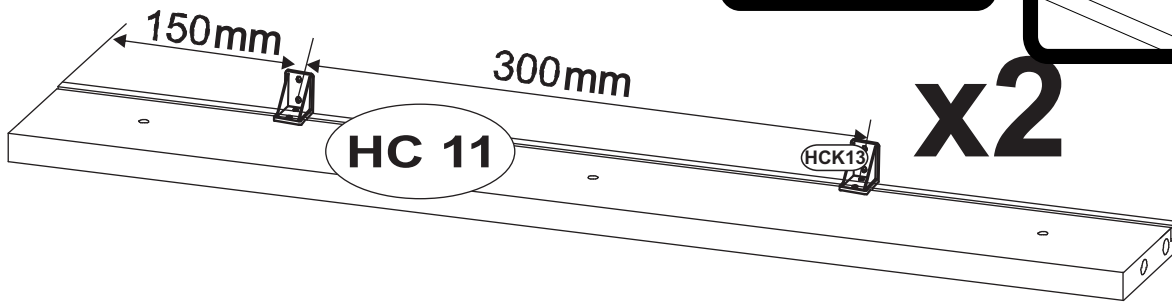
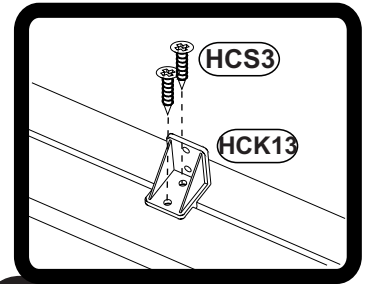
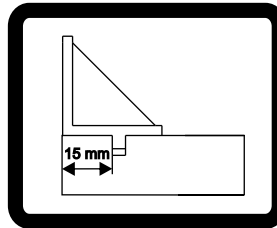
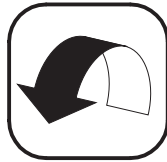
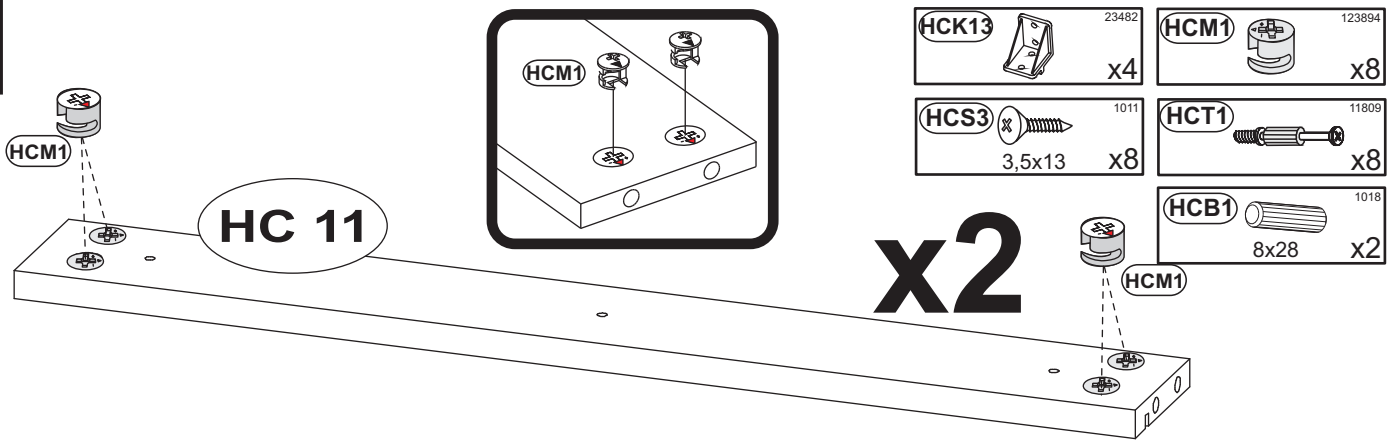

5

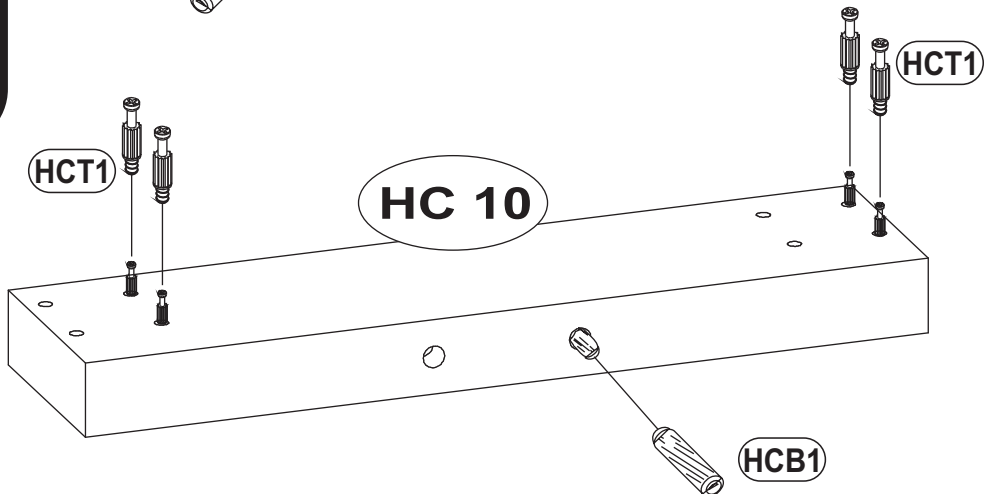

HCB1



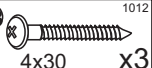



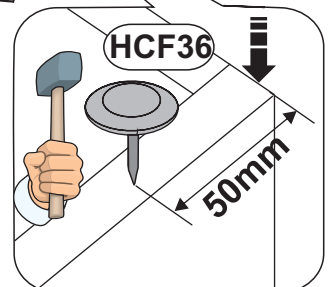
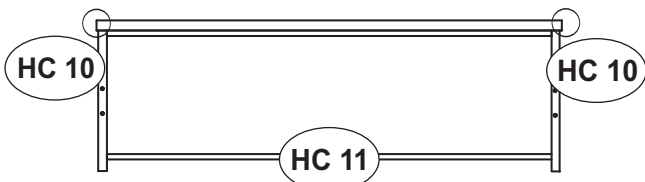
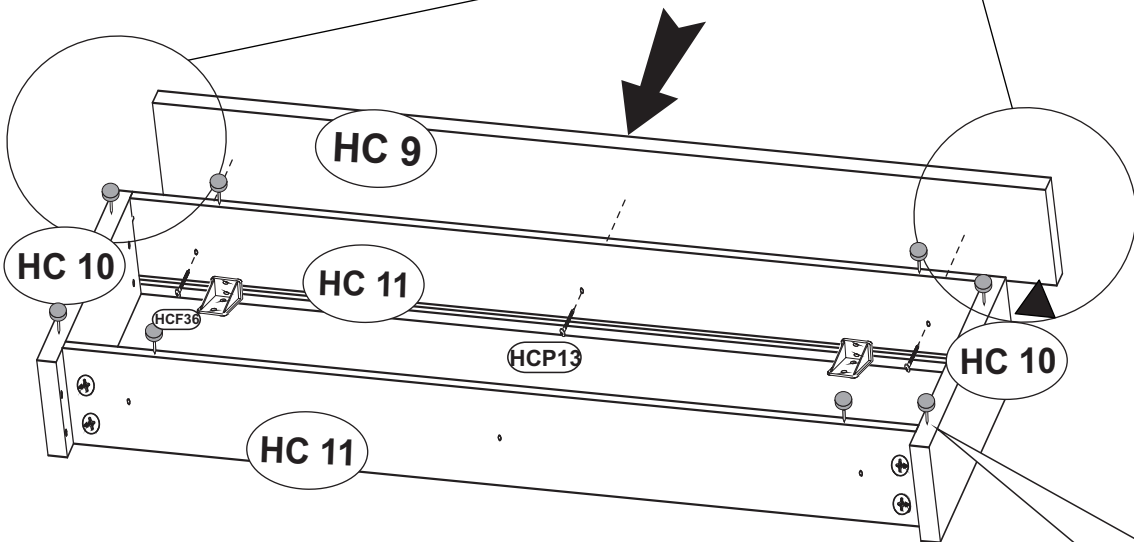
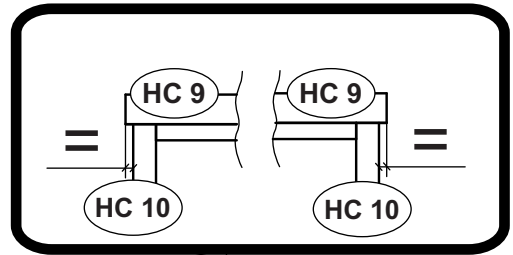
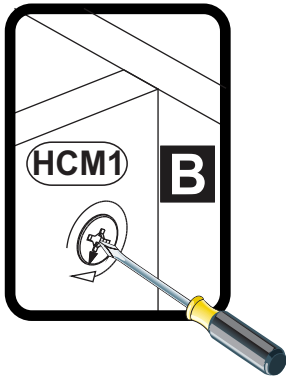
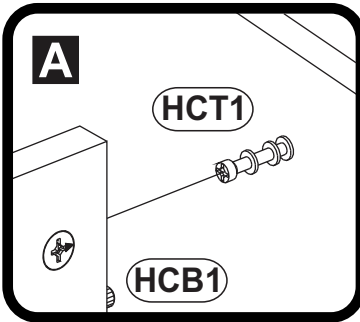
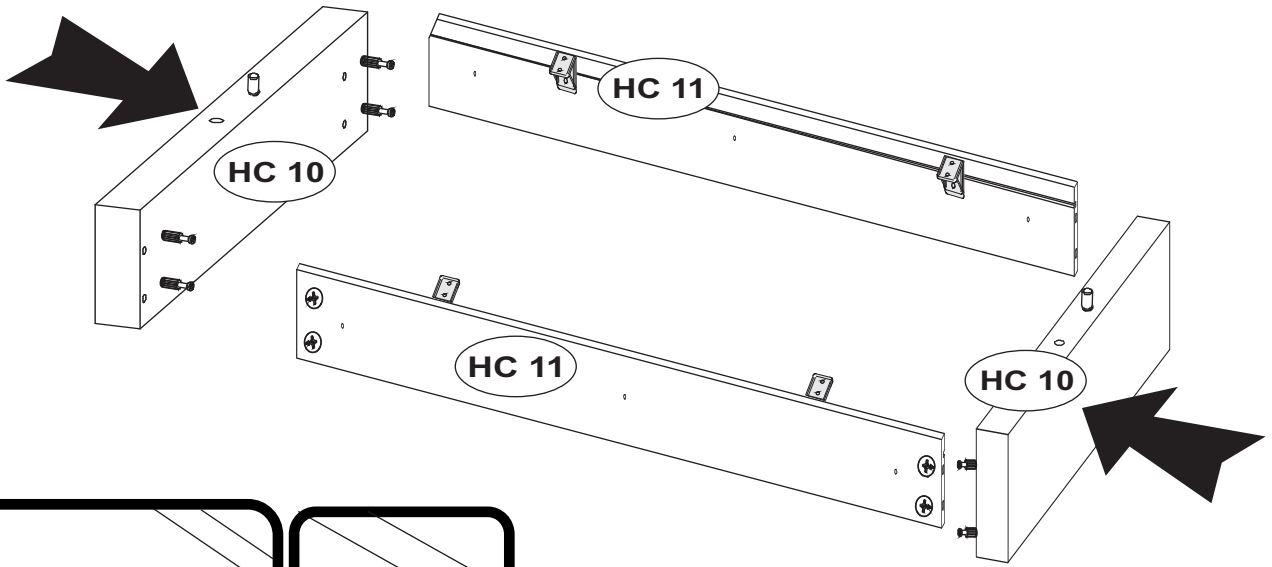

<b>HCP13</b>		1012
	4x30	x3
<b>HCF36</b>		1305
	4x30	x8

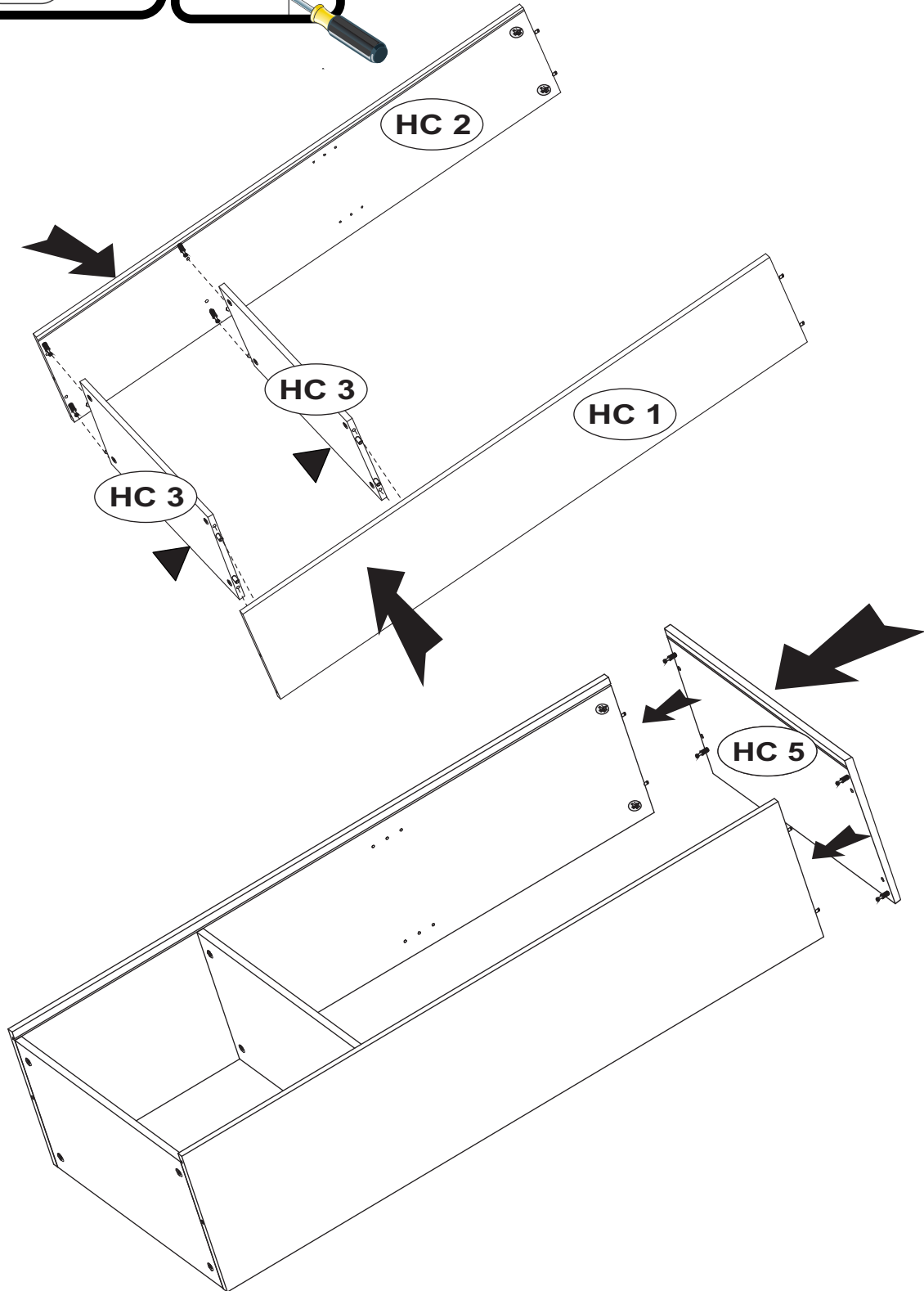
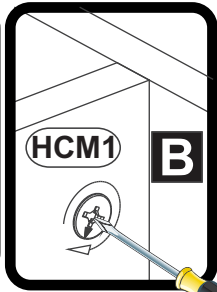
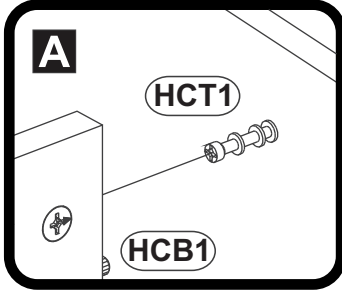

7



<b>HCS3</b>		1011
	3,5x13	x8
<b>HCP6</b>		1056
	3x20	x8
<b>HCJ23</b>		1302
		x10
<b>HCF1</b>		1415
		x4

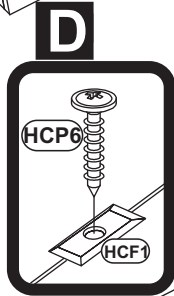
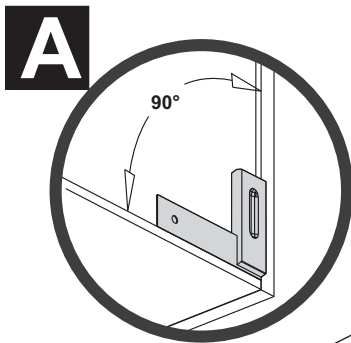
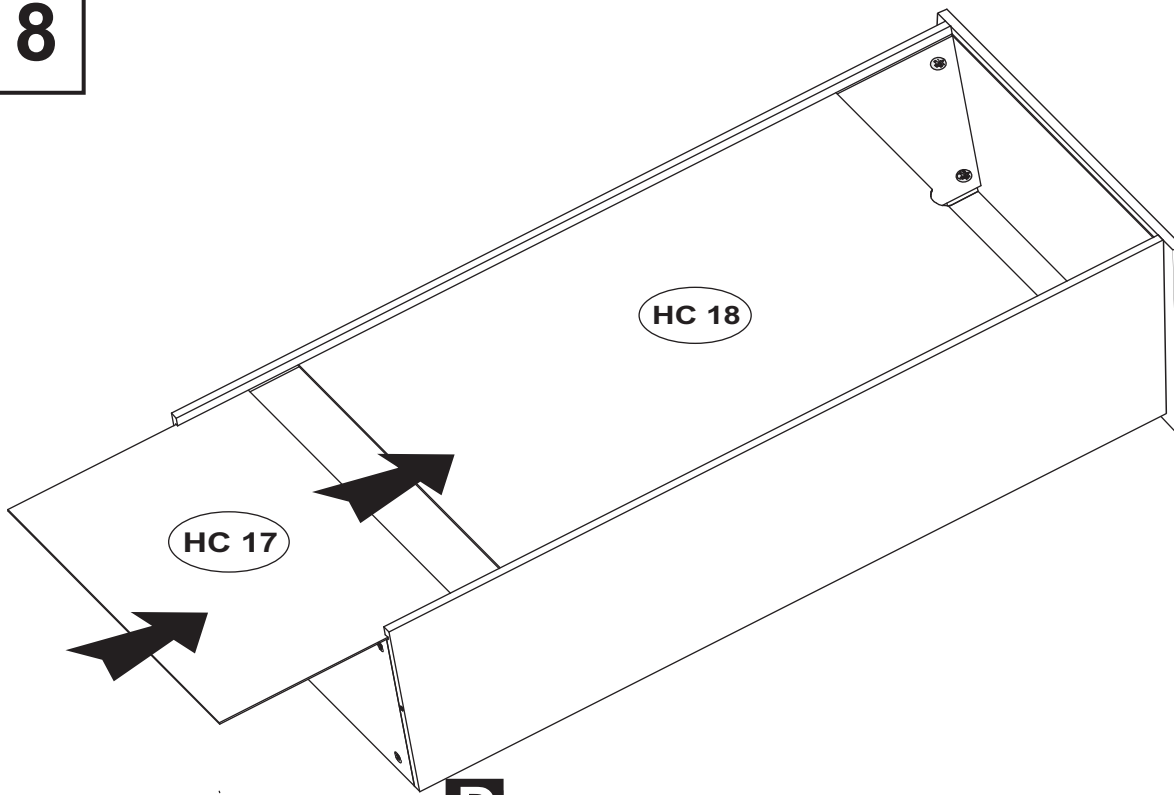

**a = b**

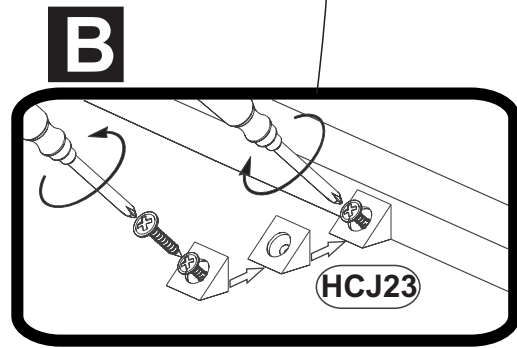
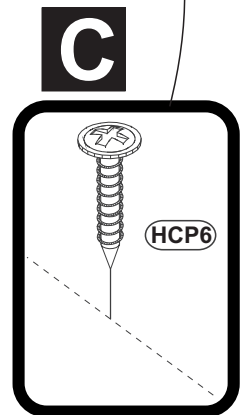
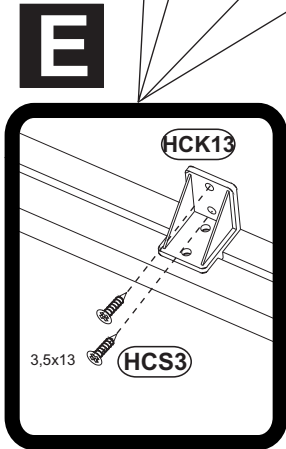
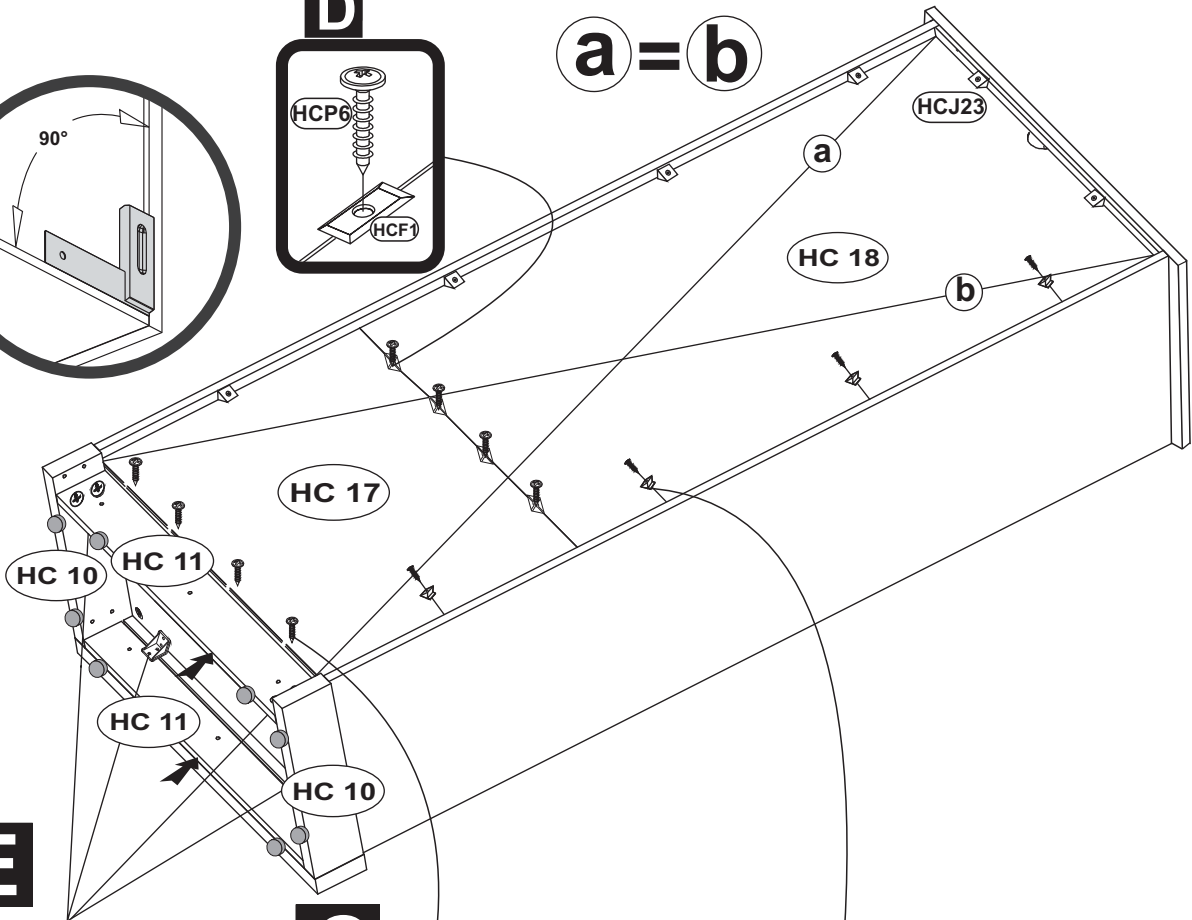

9

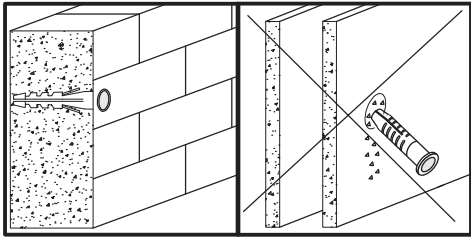

<b>HCS3</b>		1011
	3,5x13	x20
<b>HCW1</b>		1289
		x4
<b>HCJ11</b>		1267
		x1
<b>HCC115</b>		153495
	φ20	x8

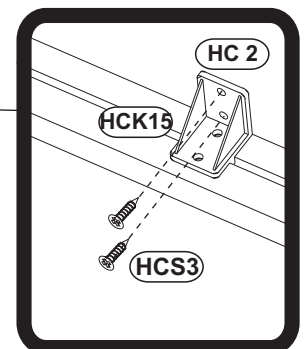
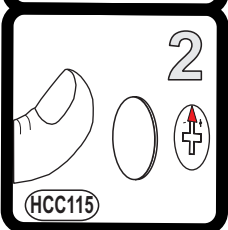
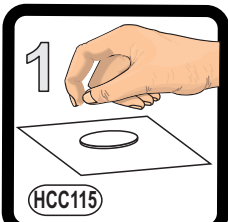
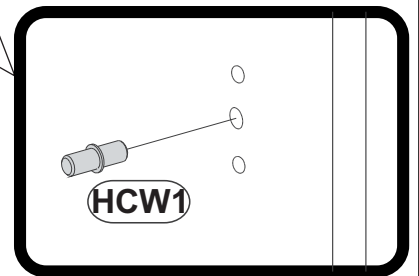
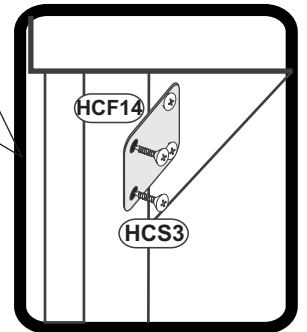
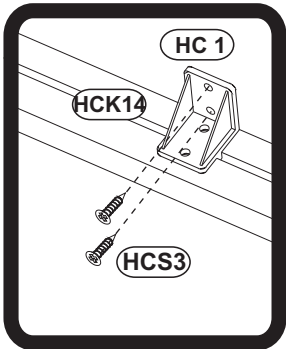
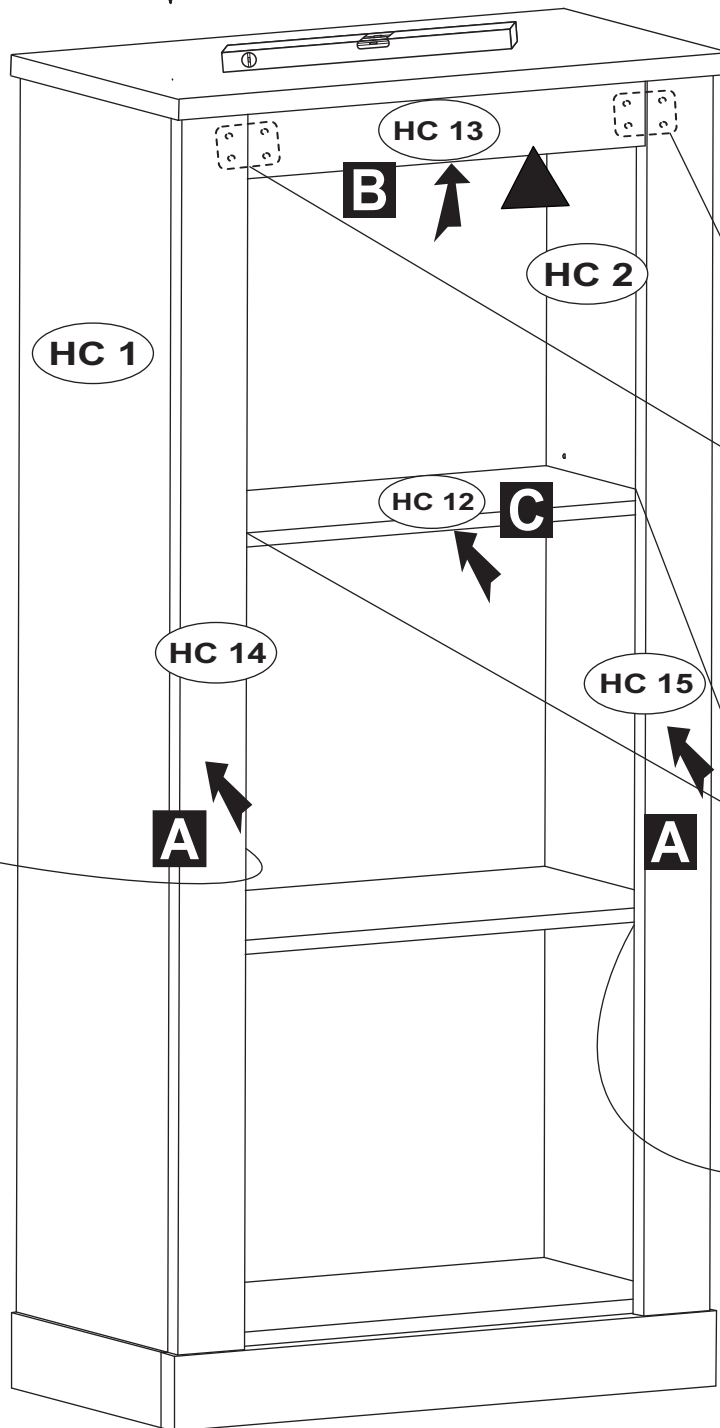
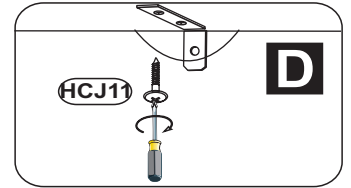
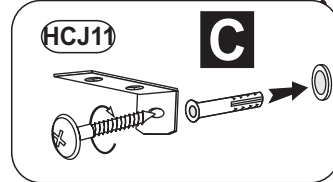
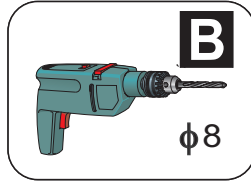
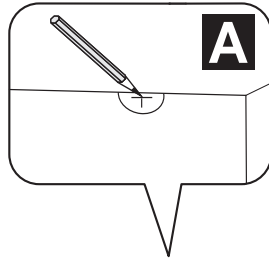

10

# OPTION L

<b>HCUC160</b>	154536
	x1
<b>HCG54</b>	126680
	x1
<b>HCP2</b>	1014
	3,5x13 x1

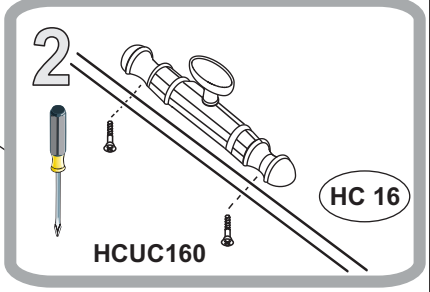
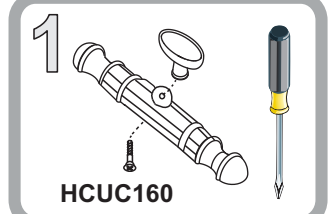
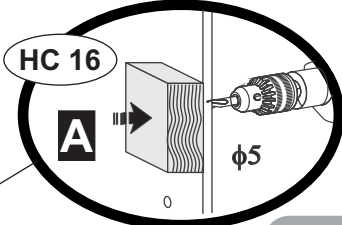
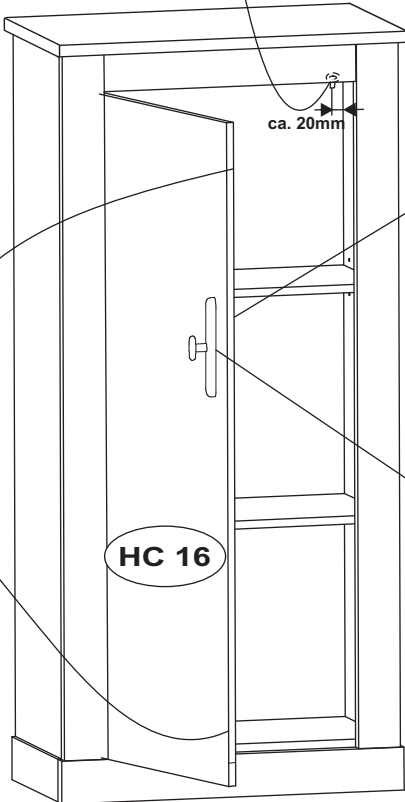
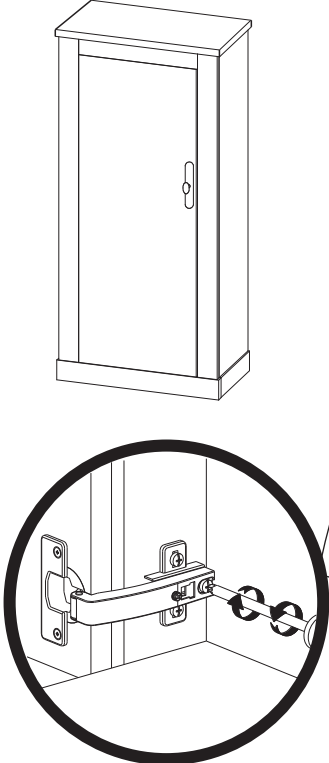

# OPTION R

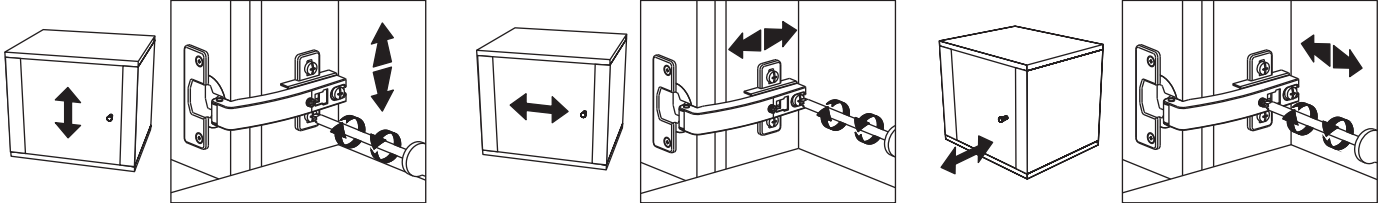
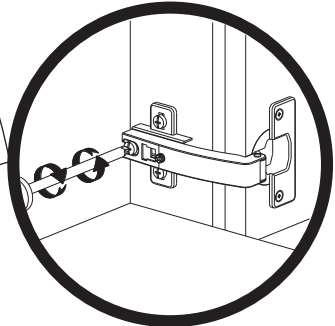
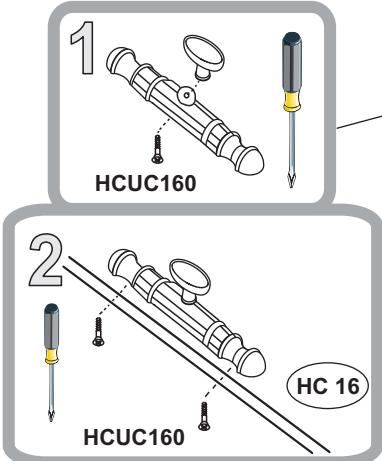
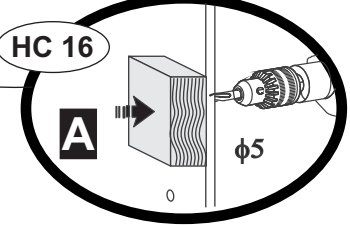
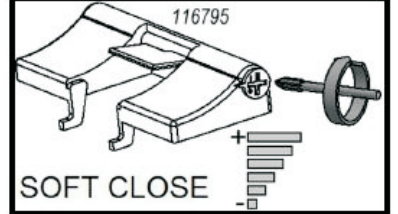
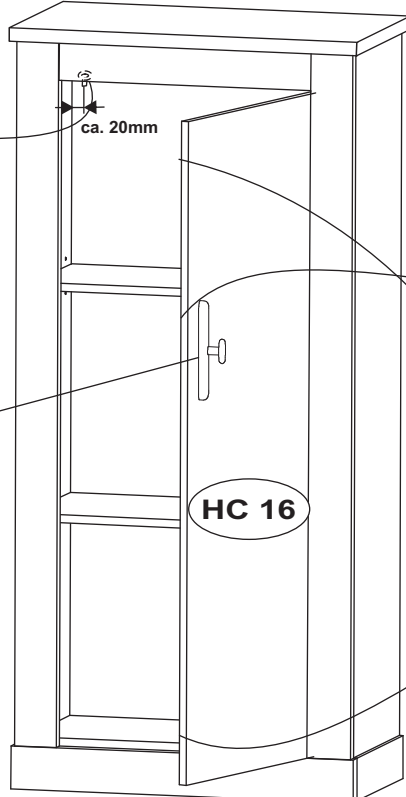
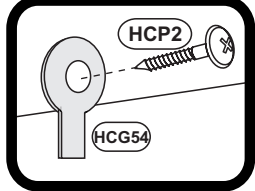
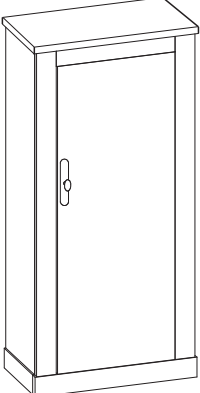

# CHAMBORD 41

OPTION L

OPTION R

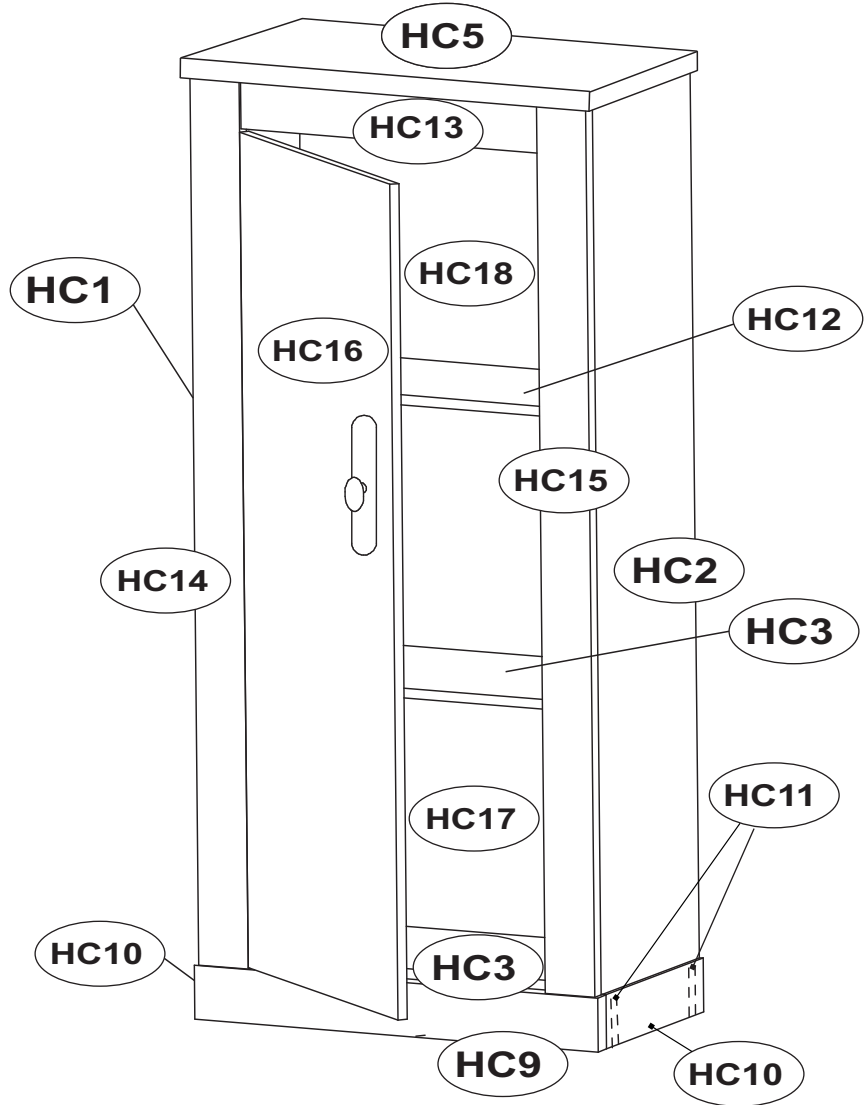
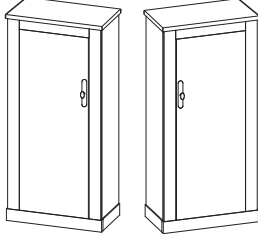

- D** Unser Direktservice für Beschlagteile  
Sollte Ihnen ein Beschlagteil fehlen, können Sie diese Servicekarte direkt an die untenstehende Adresse mailen. Wir können allerdings nur Beschlagteile auf diesem Wege verschicken. Sollten Sie eine andere Beanstandung an Ihrem Möbelstück haben, so wenden Sie sich bitte direkt an Ihr Möbelhaus.
- GB** Our direct order service for fitting  
If a fitting part is missing, you can e-mail this service card directly to the address below. However, we can only send fitting parts in this way. If you have any other cause for complaint concerning your item of furniture, please contact your furniture store directly.
- CZ** Naše přímé služby pro kování  
Chybí-li vám nějaký díl z kování, můžete tuto servisní kartu odeslat e-mailem přímo na níže uvedenou adresu. Touto cestou však můžeme zoslat jen díly kování. Pokud byste reklamovali jiný díl nábytku, obraťte se přímo na svého prodejce nábytku.
- F** Bien étudier la notice de montage  
S'il vous manque une ferrure, veuillez envoyer directement la présente carte service à l'adresse e-mail indiquée ci-dessous. Cependant, ceci nous permet uniquement d'envoyer des ferrures. Pour tout autre type de réclamation concernant votre meuble, veuillez contacter directement votre magasin d'ameublement.
- I** Il nostro servizio diretto per l'ordine della ferramenta  
Qualora Vi dovesse mancare un pezzo di fissaggio, allora Vi preghiamo di inviare questa carta di servizio immediatamente all'indirizzo sottostante. Possiamo inviare i pezzi di fissaggio solamente per mezzo di questo procedimento. Qualora dovete avere qualche altra reclamazione in merito al mobile, allora Vi preghiamo di rivolgerVi direttamente al Vostro Negozio di mobili.
- BG** Нашата директна услуга за обикове  
Ако липсват части от комплекта, попълнете настоящата сервисна карта и ни я изпратете на e-mail адреса, посочен по-долу. По този начин можем да доставяме само липсващи елементи от обикове. Ако установите други дефекти по мебелите, Ви съветваме да се обърнете към мебелната къща/магазин, от който сте закупили стоката.
- NL** Onze directservice voor losse onderdelen  
Wanneer er een onderdeel ontbreekt, kunt u deze servicekaart direct aan onderstaand e-mailadres sturen. Wij kunnen langs deze weg echter alleen beslagdelen versturen. Mocht u een ander probleem aan uw meubel hebben, verzoeken wij u contact op te nemen met uw meubeldealer.
- PL** Nasz bezpośredni serwis części montażowych  
Jeżeli brakuje części koniecznych do montażu, prosimy o przesłanie nam niniejszej karty serwisowej na niżej podany adres e-mailowy. W ten sposób możemy przesłać Państwu tylko brakujące części. W przypadku innych reklamacji dotyczących mebla, prosimy zgłosić się do salonu meblowego, w którym został dokonany zakup.
- HR** Servis za okove  
U slučaju da nedostaje neki od dijelova molimo vas da na dolje navedenu mail adresu pošaljete ovaj servisni obrazac. Na ovaj način mogu se dostaviti samo okovi. U slučaju da imate dodatne prigovore vezane uz komad namještaja molimo vas da se obratite izravno trgovini namještaja gdje je isti kupljen.
- HU** Direktszolgáltatunk vasalatók esetén  
Ha hiányzik egy vasalat, ezt a kártyát közvetlenül elküldheti az alább található címre. Azonban csak vasalatókat tudunk így küldeni. Amennyiben másfajta reklamáció áll fenn bútorárbaját illetően, forduljon közvetlenül a bútorházhöz.
- SK** Náš priamy servis pre časti kovania  
Ak by Vám chýbala nejaká časť kovania, môžete poslať túto servisnú kartu poslať e-mailom na nižšie uvedenú adresu. Diely kovania vieme poslať iba týmto spôsobom. Ak by ste mali inú reklamáciu ohľadom Vašho nábytku, obraťte sa priamo na Vašu predajňu nábytku.
- SLO** Naše direktno uslužne storitve za okovje  
Če vam manjka kakšno okovje, lahko to servisno kartico pošljete po e-pošti direktno na spodnji naslov. Po tej poti vam lahko pošljemo samo okovje. Če želite reklamirati kakšen drug del pohištva, se obrnite neposredno na vašo trgovino pohištva.
- RO** Serviciu-ul nostru direct pentru feronerie  
În cazul în care vă lipsește o piesă de feronerie puteți să trimiteți direct acest card de service prin e-mail la adresa de mai jos. Noi nu putem expedia piese de feronerie decât pe această cale. Dacă aveți o altă reclamație referitoare la piesa de mobilier, atunci vă rugăm să vă adresați direct la magazinul dvs. de mobiliă.
- RUS** Наш прямой сервис для поставок фурнитуры  
Если окажется, что Вам не хватает того или иного элемента фурнитуры, Вы можете отправить сервисную карту по факсу непосредственно на нижеприведенный адрес электронной почты. Однако, таким образом мы можем переслать лишь фурнитуру. Если же у Вас возникнут иные претензии относительно приобретенной мебели, пожалуйста, обращайтесь непосредственно в организацию, осуществившую продажу.
- S** Vår direktservice för beslagdelar  
Om du saknar en beslagdel kan du skicka detta servicekort direkt till e-postadressen som anges nedan. Tänk på att detta är den enda möjligheten att skicka beslagdelar till dig. Om du vill reklamera din möbel av en annan anledning måste du kontakta ditt möbelhus direkt.
- ES** Nuestro servicio directo para accesorios  
Si le falta algún accesorio, puede enviar esta tarjeta de servicio directamente a la siguiente dirección. No obstante, por este método solo podemos enviar accesorios. Si tiene alguna otra objeción sobre su mueble, consulte directamente con su mueblería.
- TR** Donatılar için doğrudan servisimiz  
Bir donatı için eksiğe bu servis kartını doğrudan aşağıda bulunan adrese doğrudan mail yazabilirsiniz. Sadece bu yolla donatıları gönderebiliriz. Mobilyanızda başka şikayetleriniz varsa lütfen doğrudan mobilya satıcınıza danışın.

HC 1	1311	320	15	1/1
HC 2	1311	320	15	1/1
HC 3	611	299	15	1/1
HC 5	681	362	28	1/1
HC 9	656	80	28	1/1
HC 10	317	80	28	1/1
HC 11	598	80	15	1/1

HC 12	610	267	15	1/1
HC 13	483	70	18	1/1
HC 14	1311	80	22	1/1
HC 15	1311	80	22	1/1
HC 16	1235	477	15	1/1
HC 17	421	623	2,5	1/1
HC 18	895	623	2,5	1/1

# CHAMBORD 41

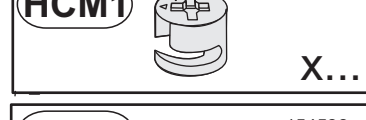
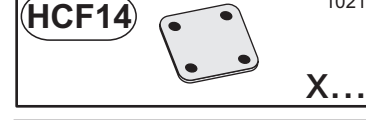
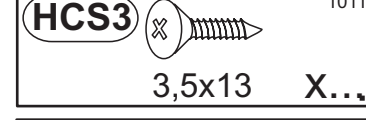
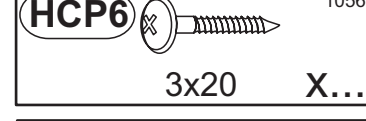
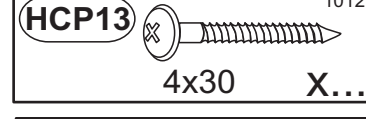
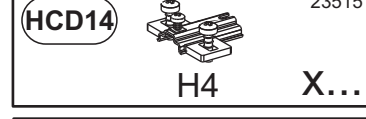
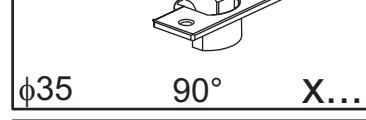
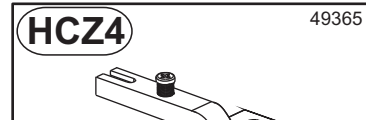
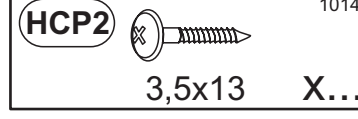
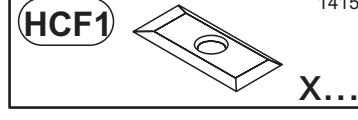
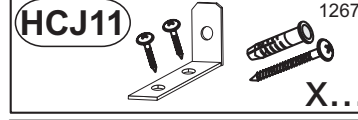
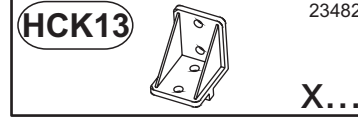
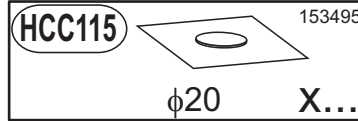
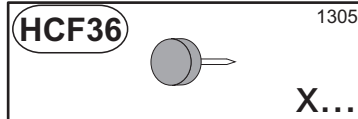
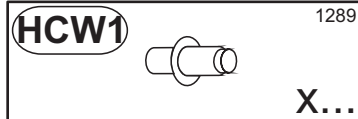
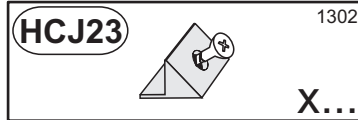
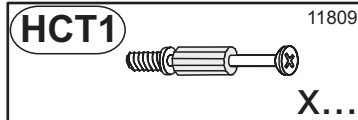

**D** Unser Direktservice für Beschlagteile  
 Sollte Ihnen ein Beschlagteil fehlen, können Sie diese Servicekarte direkt an die untenstehende Adresse mailen. Wir können allerdings nur Beschlagteile auf diesem Wege verschicken. Sollten Sie eine andere Beanstandung an Ihrem Möbelstück haben, so wenden Sie sich bitte direkt an Ihr Möbelhaus.

**GB** Our direct order service for fitting  
 If a fitting part is missing, you can e-mail this service card directly to the address below. However, we can only send fitting parts in this way. If you have any other cause for complaint concerning your item of furniture, please contact your furniture store directly.

**CZ** Naše primé služby pro kování  
 Chybí-li vám nějaký díl z kování, můžete tuto servisní kartu odeslat e-mailem přímo na níže uvedenou adresu. Touto cestou však můžeme rozesílat jen díly kování. Pokud byste reklamovali jiný díl nábytku, obraťte se přímo na svého prodejce nábytku.

**F** Bien étudier la notice de montage  
 Si l'un des éléments de montage est manquant, vous pouvez adresser directement à l'adresse e-mail indiquée ci-dessous. Cependant, ceci nous permet uniquement d'envoyer des ferrures. Pour tout autre type de réclamation concernant votre meuble, veuillez contacter directement votre magasin d'aménagement.

**I** Il nostro servizio diretto per l'ordine della ferramenta  
 Qualora Vi dovesse mancare un pezzo di fissaggio, allora Vi preghiamo di inviare questa carta di servizio immediatamente all'indirizzo sottostante. Possiamo inviare i pezzi di fissaggio solamente per mezzo di questo procedimento. Qualora doveste avere qualche altra reclamo in merito al mobile, allora Vi preghiamo di rivolgerVi direttamente al Vostro Negozio di mobili.

**BG** Нашата директна услуга за обкова  
 Ако липсват части от комплекта, попълнете настоящата сервисна карта и ни я изпратете на e-mail адреса, посочен по-долу. По този начин можем да доставяме само липсващи елементи от обкова. Ако установите други дефекти по мебелите, Ви съветваме да се обърнете към мебелната къща/магазин, от който сте закупили стоката.

**NL** Onze directservice voor losse onderdelen  
 Wanneer er een onderdeel ontbreekt, kunt u deze servicekaart direct aan onderstaand e-mailadres sturen. Wij kunnen lange deze weg echter alleen beslagdelen versturen. Mocht u een ander probleem aan uw meubel hebben, verzoeken wij u contact op te nemen met uw meubeldealer.

**PL** Nasz bezpośredni serwis części montażowych  
 Jeżeli brakuje części koniecznych do montażu, prosimy o przesłanie nam niniejszej karty serwisowej na niżej podany adres e-mailowy. W ten sposób możemy przesyłać Państwu tylko brakujące części. W przypadku innych reklamacji dotyczących mebla, prosimy zgłosić się do salonu meblowego, w którym został dokonany zakup.

**HR** Servis za okove  
 U slučaju da nedostaje neki od dijelova molimo vas da na dolje navedenu mail adresu pošaljete ovaj servisni obrazac. Na ovaj način mogu se dostaviti samo okovi. U slučaju da imate dodatne prigovore vezane uz komad namještaja molimo vas da se obratite izravno trgovini namještaja gdje je isti kupljen.

**HU** Direktszolgálatunk vasalatok esetén  
 Ha hiányzik egy vasalat, ezt a kártyát közvetlenül elküldheti az alább található címre. Azonban csak vasalatoskat tudunk így küldeni. Amennyiben másfajta reklamáció áll fenn bútorárbátját illetően, forduljon közvetlenül a bútorárbához.

**SK** Naš priamy servis pre časti kovania  
 Ak by Vám chýbala nejaká časť kovania, môžete poslať túto servisnú kartu pošťou e-mailom na nižšie uvedenú adresu. Diely kovania vieme poslať iba týmto spôsobom. Ak by ste mali inú reklamáciu ohľadom Vášho nábytku, obráťte sa priamo na Vašu predajňu nábytku.

**SLO** Naše direktne uslužne storitve za okovje  
 Če vam manjka kakšno okovje, lahko to servisno kartico pošljete po e-pošti direktno na spodnji naslov. Po tej poti vam lahko pošljemo samo okovje. Če želite reklamirati kakšen drug del pohištva, se obrnite neposredno na vašo trgovino pohištva.

**RO** Service-ul nostru direct pentru feronerie  
 In cazul in care va lipseste o piesa de feronerie puteti sa trimiteți direct acest card de service prin e-mail la adresa de mai jos. Noi nu putem expedia piese de feronerie decât pe această cale. Dacă aveți o altă reclamație referitoare la piesa de mobilier, atunci vă rugăm să vă adresați direct la magazinul dvs. de mobilier.

**RUS** Наш прямой сервис для поставок фурнитуры  
 Если окажется, что Вам не хватает того или иного элемента фурнитуры, Вы можете отправить сервисную карту по факсу непосредственно на нижеприведенный адрес электронной почты. Однако, таким образом мы можем пересылать лишь фурнитуру. Если же у Вас возникнут иные претензии относительно приобретенной мебели, пожалуйста, обращайтесь непосредственно в организацию, осуществившую продажу.

**S** Vir direktservice för beslagsdelar  
 Om du saknar en beslagsdel kan du skicka detta servicekort direkt till e-postadressen som anges nedan. Tänk på att detta är den enda möjligheten att skicka beslagsdelar till dig. Om du vill reklamera din möbel av en annan anledning måste du kontakta ditt möbelhus direkt.

**ES** Nuestro servicio directo para accesorios  
 Si le falta algún accesorio, puede enviar esta tarjeta de servicio directamente a la siguiente dirección. No obstante, por este método solo podemos enviar accesorios. Si tiene alguna otra objeción sobre su mueble, consulte directamente con su mueblería.

**TR** Donatılar için doğrudan servisimiz  
 Bir donatınız eksikse bu servis kartını doğrudan ağıdına bulunan adrese doğrudan mail yazabilirsiniz. Sadece bu yolla donatıları gönderebiliriz. Mobilyanızda başka şikayetleriniz varsa lütfen doğrudan mobilya satıcınıza danışın.

